

MTB & Road Disc Brake

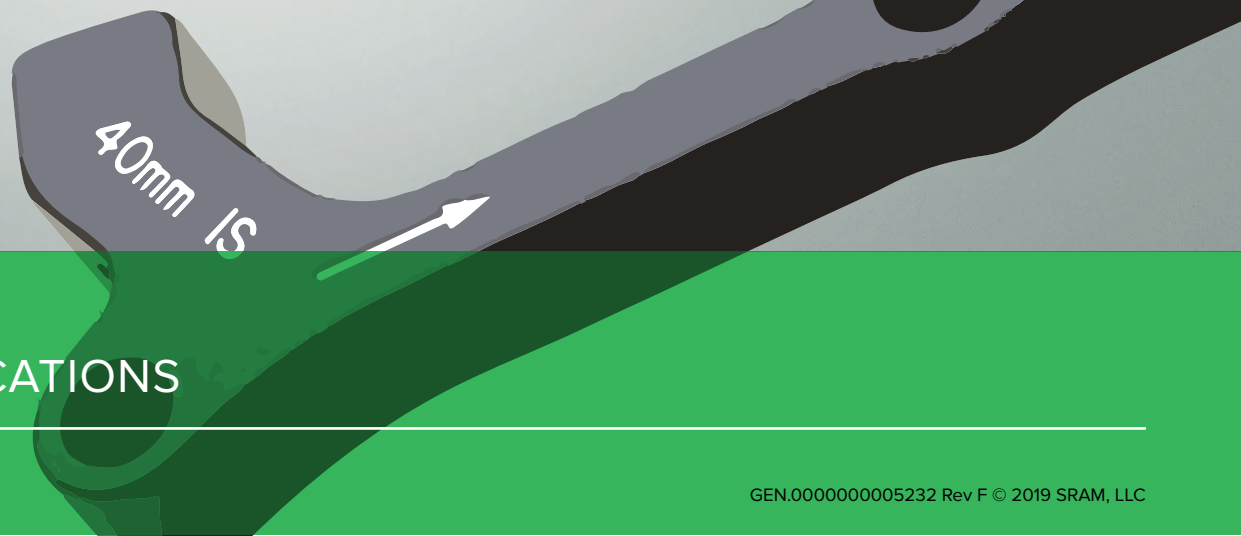
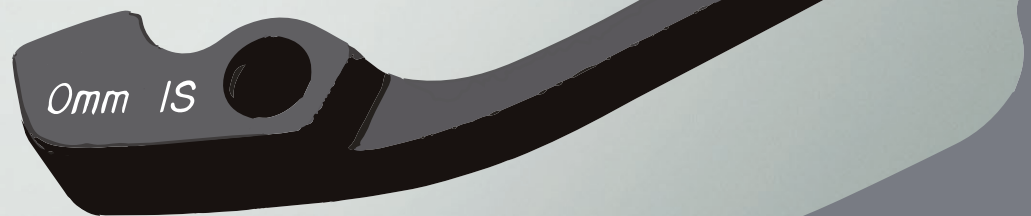

CALIPER MOUNTING SPECIFICATIONS

Table of Contents

Caliper Mounting Options	3
Flat Mount, Post Mount, and International Standard Mount.....	4
Post Mount and CPS.....	5
Disc Brake Mounting Chart.....	6
Mounting Hardware	7
Post Mount Caliper	
G2/ Guide/ Level/ DB/ XX/ X0/ CODE 2017+ /Elixir 2013+ /SRAM RED eTap AXS HRD/ SRAM RED eTap HRD/ SRAM RED HRD/ SRAM FORCE HRD/ SRAM RIVAL HRD/ SRAM APEX HRD/ SRAM S-700/	8
G2/ Guide/ Level/ DB/ XX/ X0/ CODE 2017+ /Elixir 2013+ /SRAM RED eTap AXS HRD/ SRAM RED eTap HRD/ SRAM RED HRD/ SRAM FORCE HRD/ SRAM RIVAL HRD/ SRAM APEX HRD/ SRAM S-700/	9
CPS Caliper	
Guide RE/ Code Pre 2017/ Code R Pre 2017/ Juicy/ Elixir Pre 2013/ BB7/ BB5/ BB3/ BB7 Road/ BB5 Road.....	10
Guide RE/ Code Pre 2017/ Code R Pre 2017/ BB7/ BB5/ BB3/ Juicy/ Elixir Pre 2013	11
Flat Mount Caliper	
SRAM RED eTap AXS HRD/ SRAM FORCE eTap AXS HRD/ SRAM RED eTap HRD/ SRAM RED HRD/ SRAM FORCE HRD/ SRAM RIVAL HRD/ SRAM APEX HRD/ S-900 Aero	12
SRAM RED eTap AXS HRD/ SRAM FORCE eTap AXS HRD/ SRAM RED eTap HRD/ SRAM RED HRD/ SRAM FORCE HRD/ SRAM RIVAL HRD/ SRAM APEX HRD/ S-900 Aero/ Level Ultimate/ Level TLM	13

Caliper Mounting Options

Flat Mount, Post Mount, and International Standard Mount

Flat Mount

Flat Mount Tabs

A bracket may be needed to attach the caliper to the frame or fork.

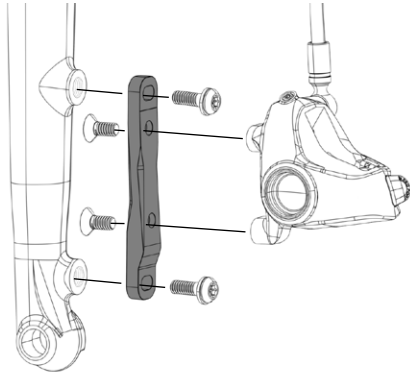

Flat Mount Rear

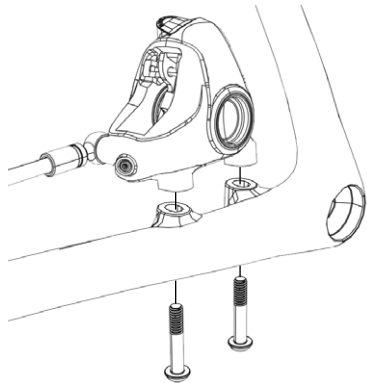

Post Mount

Direct Mount (Direct)

No post brackets or spacers are needed to attach the caliper to the frame or fork.

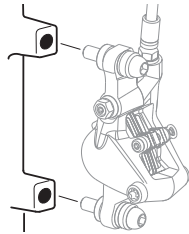

Post Spacers (S)

Some rotor sizes require the use of spacers to fit the caliper on the frame or fork.



Post Brackets (P)

Some rotor sizes require the use of post brackets to fit the caliper on the frame or fork.



International Standard Mount (IS)

International Standard Bracket (IS)

SRAM brakes are Post Mount. To convert an IS frame or fork to Post Mount, an IS bracket is required.

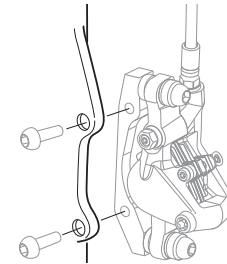

Post Mount and CPS

Post Mount

Offset Tabs

No CPS washers are needed between the caliper and mount (unless otherwise specified).

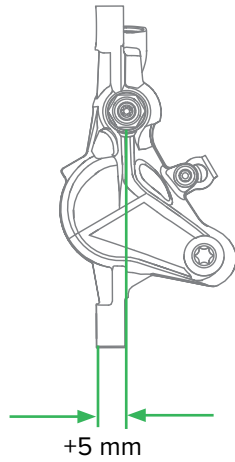

Caliper Positioning System (CPS)

Inline Tabs

CPS washers are needed between the caliper and mount (unless otherwise specified).

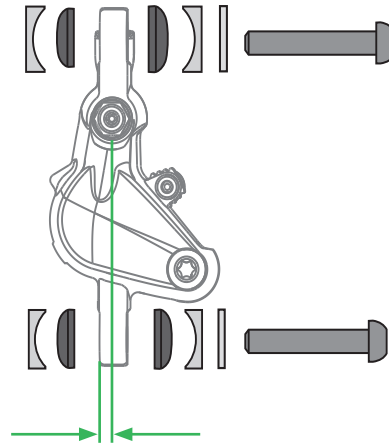





Disc Brake Mounting Chart

Identify your frame or fork's mounting standard and your preferred rotor size, then use the chart to determine the appropriate mounting configuration.

		Rotor Size							
		140 mm	160 mm	170 mm	180 mm	185 mm	200 mm	203 mm	220 mm*
Fork/ Frame	140 IS	0 IS	20 IS	30 IS	40 IS	45 IS	60 IS		
	140 Post	Direct	20 S 20 P	30 P	40 P				
	Flat	Front 0 F Rear Direct	Front 20 F Front Direct						
	160 IS		0 IS		20 IS	25 IS	40 IS		60 IS
	160 Post		Direct	10 S	20 S 20 P	25 S	40 P		
	180 Post				Direct		20 S 20 P		40 P
	200 Post BOXXER® 27						Direct	3 S	20 S 20 P
	203 Post Totem							Direct	

* The 220 mm diameter rotor is designed for use with a 4-piston caliper.

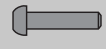
Mounting Hardware

Hardware	
	Convex Washer
	Concave Washer
	Washer
	Button Head Bolt
	Flat Head Bolt

⚠ WARNING

Choose the correct bolt length for proper thread engagement. Riding a bike with improper bolt engagement can allow the brakes to disengage from the bicycle, which can lead to a crash and serious injury or death to the rider.

There must be 9-13 mm of mounting bolt thread engagement when mounting brake calipers to forks and frames either with or without brackets and/or spacers.

There must be 5-7 mm of mounting bolt thread engagement when mounting brake calipers to frames with flat mount hardware and brackets.

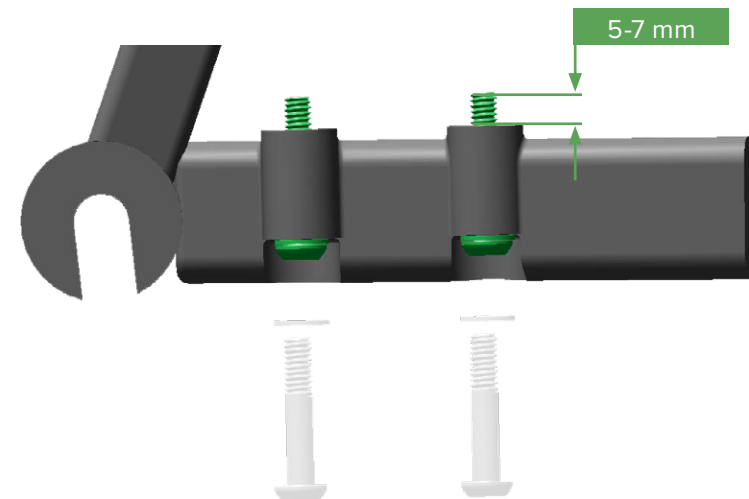
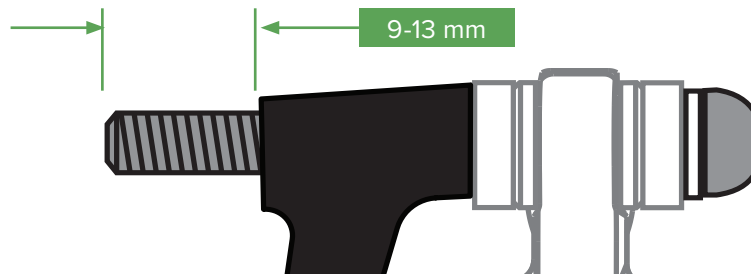

Post Mount Caliper

G2/ Guide/ Level/ DB/ XX/ X0/ CODE 2017+ /Elixir 2013+
 SRAM RED eTap AXS HRD/ SRAM RED eTap HRD/ SRAM RED HRD/ SRAM FORCE HRD/
 SRAM RIVAL HRD/ SRAM APEX HRD/ SRAM S-700/

Direct

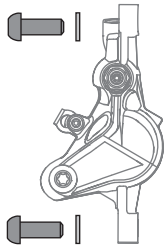

Upper Bolt		Lower Bolt	
18 mm		18 mm	

10 S

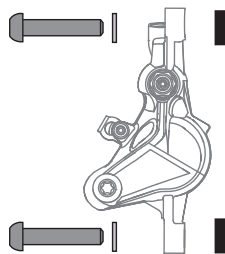

Upper Bolt	Upper Spacer	Lower Bolt	Lower Spacer
24 mm	6 mm	24 mm	6 mm

20 P

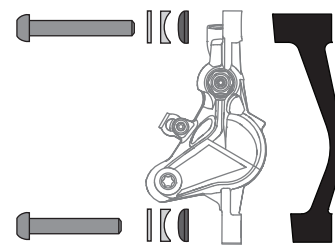

Upper Bolt		Lower Bolt	
39.5 mm		34 mm	

3 S

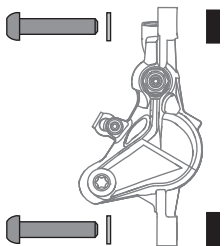

Upper Bolt	Upper Spacer	Lower Bolt	Lower Spacer
20 mm	1.5 mm	20 mm	1.5 mm

20 S

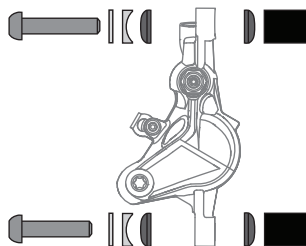

Upper Bolt	Upper Spacer	Lower Bolt	Lower Spacer
39.5 mm	12.5 mm	34 mm	7.5 mm

25 S

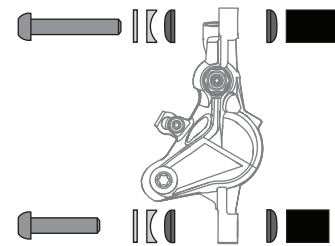

Upper Bolt	Upper Spacer	Lower Bolt	Lower Spacer
43 mm	17.5 mm	37.5 mm	10 mm

Post Mount Caliper

G2/ Guide/ Level/ DB/ XX/ X0/ CODE 2017+ /Elixir 2013+
 SRAM RED eTap AXS HRD/ SRAM RED eTap HRD/ SRAM RED HRD/ SRAM FORCE HRD/
 SRAM RIVAL HRD/ SRAM APEX HRD/ SRAM S-700/

30 P

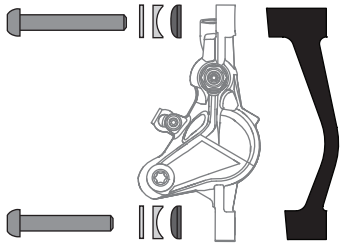

Upper Bolt		Lower Bolt	
46 mm		39.5 mm	

IS

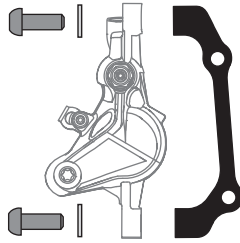

Upper Bolt		Lower Bolt	
18 mm		18 mm	

40 P

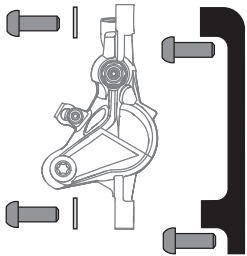

Upper Bolt	Bracket Bolt	Lower Bolt	Bracket Bolt
18 mm	18 mm	18 mm	18 mm

CPS Caliper

Guide RE/ Code Pre 2017/ Code R Pre 2017/ Juicy/ Elixir Pre 2013/ BB7/ BB5/ BB3/
BB7 Road/ BB5 Road

Direct

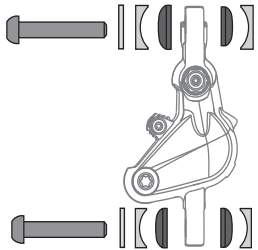

Upper Bolt		Lower Bolt	
29 mm		29 mm	

20 S

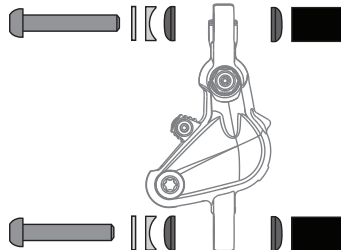

Upper Bolt	Upper Spacer	Lower Bolt	Lower Spacer
44 mm	17.5 mm	39.5 mm	12.5 mm

25 S

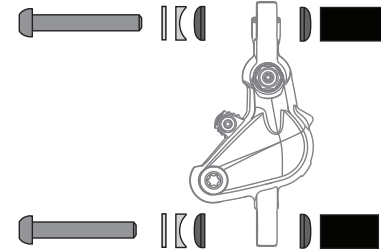

Upper Bolt	Upper Spacer	Lower Bolt	Lower Spacer
46 mm	20.5 mm	40.5 mm	15 mm

10 S

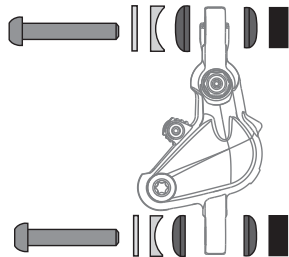

Upper Bolt	Upper Spacer	Lower Bolt	Lower Spacer
39.5 mm	12.5 mm	34 mm	7.5 mm

20 P

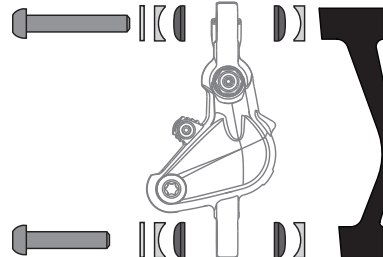

Upper Bolt		Lower Bolt	
44 mm		39.5 mm	

30 P

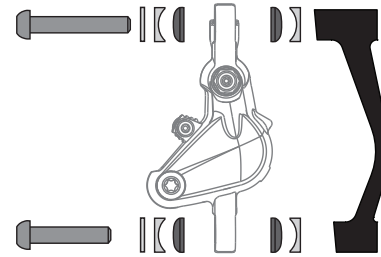

Upper Bolt		Lower Bolt	
50 mm		44 mm	

CPS Caliper

Guide RE/ Code Pre 2017/ Code R Pre 2017/ BB7/ BB5/ BB3/ Juicy/ Elixir Pre 2013

40 P

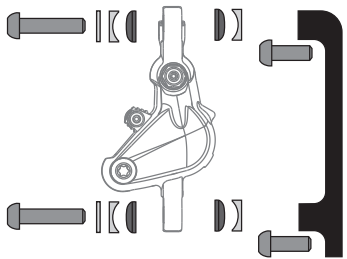

Upper Bolt	Bracket Bolt	Lower Bolt	Bracket Bolt
29 mm	18 mm	29 mm	18 mm

IS

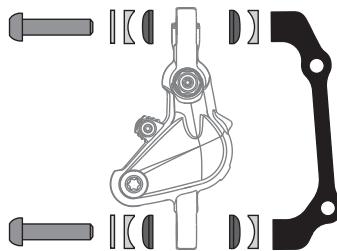

Upper Bolt		Lower Bolt	
29 mm		29 mm	

Flat Mount Caliper

SRAM RED eTap AXS HRD/ SRAM FORCE eTap AXS HRD/ SRAM RED eTap HRD/ SRAM RED HRD/
SRAM FORCE HRD/ SRAM RIVAL HRD/ SRAM APEX HRD/ S-900 Aero

Front 0 F

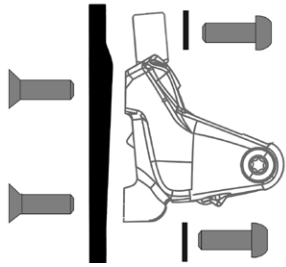

Upper Button Head Bolt	Lower Button Head Bolt	Flat Head Bolt	Flat Head Bolt
15 mm	15 mm	10.7 mm	10.7 mm

Front 20 F

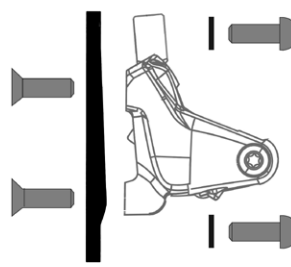

Upper Button Head Bolt	Lower Button Head Bolt	Flat Head Bolt	Flat Head Bolt
15 mm	15 mm	10.7 mm	10.7 mm

Flat Mount Caliper

SRAM RED eTap AXS HRD/ SRAM FORCE eTap AXS HRD/ SRAM RED eTap HRD/ SRAM RED HRD/
SRAM FORCE HRD/ SRAM RIVAL HRD/ SRAM APEX HRD/ S-900 Aero/
Level Ultimate/ Level TLM

Bolts and brackets may need to be purchased separately.

Front Direct / Rear Direct

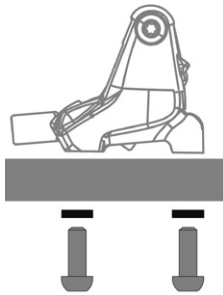

Chainstay Frame Thickness	Button Head Bolts
10 mm	17 mm
15 mm	22 mm
20 mm	27 mm
25 mm	32 mm
30 mm	37 mm
35 mm	42 mm

Rear 20 F

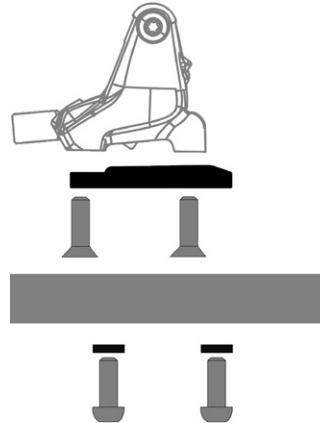

Chainstay Frame Thickness	Button Head Bolts	Flat Head Bolts
10 mm	17 mm	10.7 mm
15 mm	22 mm	10.7 mm
20 mm	27 mm	10.7 mm
25 mm	32 mm	10.7 mm
30 mm	37 mm	10.7 mm
35 mm	42 mm	10.7 mm

These are registered trademarks of SRAM, LLC:

1:1®, Accuwatt®, Avid®, Bar®, Blackbox®, BoXXer®, DoubleTap®, Elita®, eTap®, Firecrest®, Firex®, Grip Shift®, GXP®, Hammerschmidt®, Holzfelder®, Hussefelt®, i-Motion®, Judy®, Know Your Powers®, NSW®, Omnium®, Pike®, PowerLock®, Quarq®, Qollector®, RacerMate®, Reba®, Rock Shox®, Ruktion®, Service Course®, ShockWiz®, SID®, Single Digit®, Speed Dial®, Speed Weaponry®, Spinscan®, SRAM®, SRAM APEX®, SRAM EAGLE®, SRAM FORCE®, SRAM RED®, SRAM RIVAL®, SRAM VIA®, Stylo®, Torpedo®, The Power of Bicycles®, Truvativ®, Varicrank®, Velotron®, World Bicycle Relief®, XO®, XO1®, X-SYNC®, XX1®, Zed tech®, ZIPP®

These are registered logos of SRAM, LLC:



These are trademarks of SRAM, LLC:

10K™, 1X™, 202™, 30™, 302™, 303™, 3ZERO MOTO™, 404™, 454™, 808™, 858™, ABLC™, AeroGlide™, AeroBalance™, AeroLink™, Airea™, Air Guides™, AKA™, AL-7050-TV™, Automatic Drive™, Automatix™, AxCad™, Axial Clutch™, AXS™, BB5™, BB7™, BB30™, Bleeding Edge™, Blipbox™, BlipClamp™, BlipGrip™, Blips™, Bluto™, Bottomless Tokens™, Cage Lock™, Carbon Bridge™, Centera™, Charger 2™, Charger™, Clickbox Technology™, Clics™, Code™, Cognition™, Connectamajig™, Counter Measure™, DD3™, DD3 Pulse™, DebonAir™, Deluxe™, Deluxe Re:Aktiv™, Descendant™, DFour™, DFour91™, Dig Valve™, DirectLink™, Direct Route™, DOT 5.1™, Double Decker™, Double Time™, Dual Flow Adjust™, Dual Position Air™, DUB™, DZero™, E300™, E400™, Eagle™, E-Connect4™, E-matic™, ErgoBlade™, ErgoDynamics™, ESP™, EX1™, Exact Actuation™, Exogram™, Flow Link™, FR-5™, Full Pin™, Guide™, GX™, Hard Chrome™, Hexfin™, HollowPin™, Howitzer™, HRD™, Hybrid Drive™, Hyperfoil™, i-3™, Impress™, Jaws™, Jet™, Kage™, Komfy™, Level™, Lyrik™, MatchMaker™, Maxle™, Maxle 360™, Maxle DH™, Maxle Lite™, Maxle Lite DH™, Maxle Stealth™, Maxle Ultimate™, Micro Gear System™, Mini Block™, Mini Cluster™, Monarch™, Motion Control™, Motion Control DNA™, MRX™, Noir™, NX™, OCT™, OmniCal™, OneLoc™, Paragon™, PC-1031™, PC-1110™, PC-1170™, PG-1130™, PG-1050™, PG-1170™, Piggyback™, Poploc™, Power Balance™, Power Bulge™, PowerChain™, PowerDomeX™, Powered by SRAM™, PowerGlide™, PowerLink™, Power Pack™, Power Spline™, Predictive Steering™, Pressfit™, Pressfit 30™, Prime™, Qalvin™, R2C™, RAIL™, Rapid Recovery™, Re:Aktiv ThruShaft™, Recon™, Reverb™, Revelation™, Riken™, Rise™, ROAM™, Roller Bearing Clutch™, RS-1™, Sag Gradients™, Sawtooth™, SCT - Smart Coasterbrake Technology, Seeker™, Sektor™, SHIFT™, ShiftGuide™, Shorty™, Showstopper™, Side Swap™, Signal Gear Technology™, SL™, SL-70™, SL-70 Aero™, SL-70 Ergo™, SL-80™, SL-88™, SLC2™, SL SPEED™, SL Sprint™, Smart Connect™, Solo Air™, Solo Spoke™, SpeedBall™, Speed Metal™, SRAM APEX 1™, SRAM Force 1™, SRAM RIVAL 1™, S-series™, Stealth-a-majig™, StealthRing™, Super-9™, Supercork™, Super Deluxe™, Super Deluxe Coil™, SwingLink™, TaperCore™, Timing Port Closure™, Tool-free Reach Adjust™, Top Loading Pads™, Torque Caps™, TRX™, Turnkey™, TwistLoc™, Tyrewiz™, UDH™, VCLC™, Vivid™, Vivid Air™, Vuka Aero™, Vuka Alumina™, VukaBull™, Vuka Clip™, Vuka Fit™, Wide Angle™, WiFLI™, X1™, X5™, X7™, X9™, X-Actuation™, XC™, X-Dome™, XD™, XD Driver Body™, XDR™, XG-1150™, XG-1175™, XG-1180™, XG-1190™, X-Glide™, X-GlideR™, X-Horizon™, XLoc Sprint™, XX™, Yari™, Zero Loss™



Specifications and colors subject to change without prior notice.

© 2019 SRAM, LLC

ASIAN HEADQUARTERS

SRAM Taiwan
No. 1598-8 Chung Shan Road
Shen Kang Hsiang, Taichung City
Taiwan R.O.C.

WORLD HEADQUARTERS

SRAM LLC
1000 W. Fulton Market, 4th Floor
Chicago, Illinois 60607
U.S.A.

EUROPEAN HEADQUARTERS

SRAM Europe
Paasbosweg 14-16
3862ZS Nijkerk
The Netherlands